

MATERIAL SPECIFICATION & INSTALLATION GUIDE

PRODUCT ITEM CODE & DESCRIPTION

MLR 120 Series ~ DISABLED WC WRAP AROUND 90° GRAB RAIL / BACK REST SET

MATERIAL SPECIFICATION:

#304 Grade Stainless Steel 32mm \varnothing Tubing, #3 Finish / Concealed Fix 75mm \varnothing Wall Mount Flanges / All Welds Seamless and Linished / Back Rest options – Padded White PVC (120 BR) or Stainless Steel Vandal Resistant (120 BR VP) /Full Installation Instructions Provided with each unit

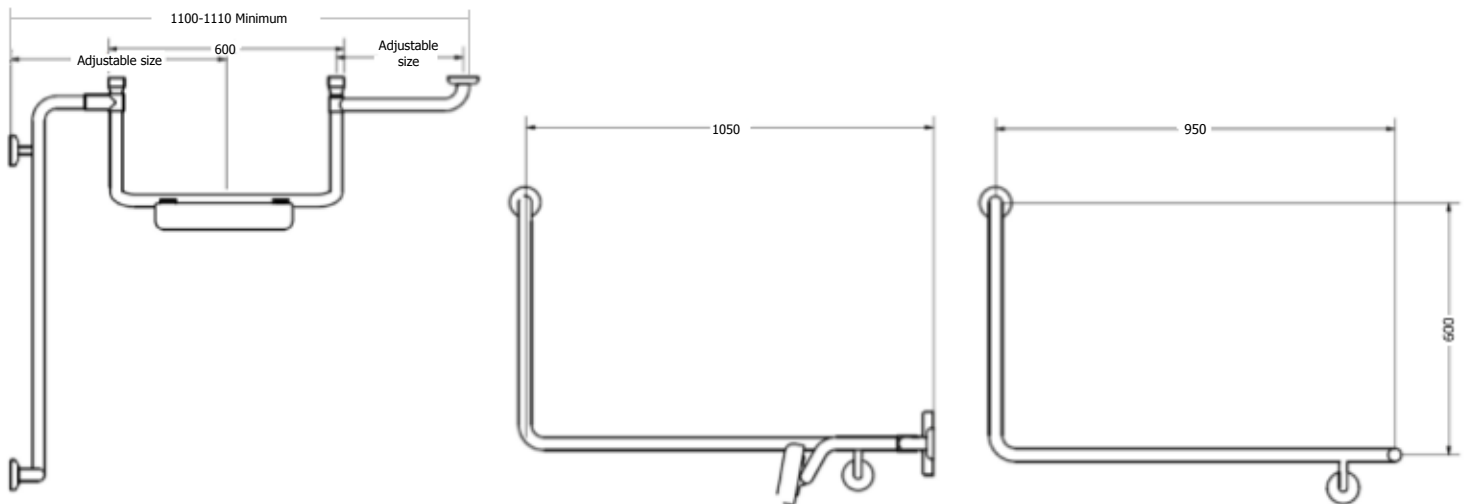

INSTALLATION GUIDE:

These units are to be surface mounted and are subject to compliance to Building Code of Australia and/or AS 1428.1 for height location and fitment for disabled/accessible use as may be applicable, which is the responsibility of the installation contractor.

Anchors are not included with the units and are the responsibility of the installation contractor, as is the compliance re fitment of internal wall blocking, such as noggins for anchoring the unit to via appropriate hardware.



All Metlam Disabled/Accessible Products Comply To AS 1428.1 When Correctly Installed

These units should only be installed by a competent tradesperson and Metlam Australia takes no responsibility for any damage to walls or fixtures due to incorrect installation.